

# Spedo 2500 Forms Cutter

Operator Manual  
Issue 3  
Part Number SP 007 301



Spedo UK Limited  
76 Woolmer Way  
Bordon  
Hampshire  
GU35 9QF  
ENGLAND



<b>Telephone:</b>	+44 (0) 1420 487 442
<b>Fax:</b>	+44 (0) 1420 477 827
<b>Email:</b>	<a href="mailto:spedo@spedouk.com">spedo@spedouk.com</a>
<b>Web:</b>	<a href="http://www.spedouk.com">www.spedouk.com</a>

# Spedo 2500 Forms Cutter

## History Sheet

Manual Issue	Date	Changes Incorporated
1	May 2015	First Edition
2	May 2015	Changed Format
3	September 2018	Correction to text

# Spedo 2500 Forms Cutter

## Publisher

Published by Spedo UK Limited  
76 Woolmer Way  
Bordon  
Hampshire  
GU35 9QF  
ENGLAND

## Copyright

Spedo UK Limited 2015

## All Rights Reserved.

No part of this publication may be reproduced, stored in a retrieval system, or transmitted, in any form or by any means, electronic, mechanical, photocopying, recording, or otherwise, without the prior written permission of Spedo UK Limited.

## Unpack

Unpack the equipment and examine it thoroughly to ascertain whether any damage has occurred in transit. Report immediately any such damage to the agent or manufacturer. Retain the packing should further transportation be necessary.

## All Goods

All goods manufactured by the Company are guaranteed to the extent hereafter mentioned against defects arising from faulty material or workmanship subject to the goods not having suffered maltreatment or interference. The Company's liability under this guarantee is limited to replacing any part or parts found defective within a period as laid down in Company instructions after the date of delivery or installation.

## Other Goods

If goods not of the Company's manufacture are ordered, the guarantee of that company is to be accepted.

## Descriptive Matter

Descriptive matter, illustrations, dimensions and weights issued by the Company are typical and shall not be held as binding.

## Patterns and Designs

The Company reserves the right to alter patterns and designs without notice.

## First Published May 2015

We have taken every care in the preparation of this manual. If there are any inaccuracies, ambiguities or omissions, Spedo UK Limited and its consultants and distributors cannot accept responsibility for any loss or damage these errors may cause.

# Spedo 2500 Forms Cutter

## Safety Measures

This instruction manual contains certain WARNING and CAUTION notices which must be followed by the user to ensure safe operation and to retain the equipment in a SAFE condition.

All users of the equipment described in this manual MUST have received adequate training in its use and application in order to ensure SAFE AND PROPER USE.

Any adjustment, maintenance or repair of the opened apparatus under voltage shall be carried out only by a skilled person who is AWARE OF THE HAZARD INVOLVED.

## Spedo 2500 Forms Cutter

### Table of Contents

History Sheet.....	2
Copyright.....	3
Safety Measures.....	4
Table of Contents.....	5

### GENERAL DESCRIPTION

### SECTION 1

INTRODUCTION .....	7
TECHNICAL DATA.....	8
DESCRIPTION OF OPERATION .....	9
Spedo 2500 Forms Cutter.....	9
Operation with Web Control Units 970/971.....	10
Operation with a Printer or Collator .....	10
MODES OF CUT.....	11
Introduction.....	11
Setting the Form Depth .....	12
Setting the Strip Depth in Dual Cut Mode.....	18
APPENDIX A1 Optional Accessories .....	19
APPENDIX A2 Residual Current Device .....	20

### COMMISSIONING THE SYSTEM

### SECTION 2

INTRODUCTION .....	21
UNPACK .....	21
ACCESSORIES .....	21
SITE CONSIDERATIONS .....	21
INSTALLATION .....	21
Connecting the Mains (Power) Lead .....	21
Installation Checks.....	21

### OPERATING INSTRUCTIONS

### SECTION 3

SUMMARY OF CONTROLS .....	26
Paper Transport deck .....	26
Control Panel .....	26
OPERATING PROCEDURE.....	26
Summary of Controls - Pushbuttons.....	27
Mode Selection.....	28
Counter / Batch Mode Operation .....	30
Maximum Speed Operation .....	31
Optical Mark Recognition (OMR) Operation .....	33
Enhanced Mode - Edit Sequence.....	35
Enhanced Mode - Job Definition Sequence .....	38
User Menu Settings .....	39
<b>WARNINGS</b> .....	44
Paper Loading .....	44

Operation from the Control Panel.....	45
Preliminary Manual Cut Operation.....	45
Setting Side Trimmers.....	46
Setting Centre Cutter .....	47
Start Continuous Operation.....	48
Stop Continuous Operation .....	48
Emergency Stop Operation.....	48
Paper Run-out.....	48

## OPERATIONAL MAINTENANCE

## SECTION 4

<b>WARNINGS</b> .....	49
<b>CLEANING</b> .....	49
<b>LUBRICATION</b> .....	49
<b>WARNING: Lithium Batteries</b> .....	49

## GENERAL DESCRIPTION

## SECTION 1

### INTRODUCTION

The Spedo 2500 Forms Cutter is designed to produce cut sheets from single or multiple continuous paper webs. In addition, the machine can also optionally trim away either or both carrier strips and optionally centre cut the paper web.



**Fig 1.1 Spedo 2500 Forms Cutter**

A normal cross-cut is made at the perforation line across the paper web. However, the machine is also capable of operating in double cross-cut mode, when it is required to cut before and after the perforation (so removing the perforation).

The depth of form to be cut, depth of strip and feed are all measured in terms of line increments, either as a 6 lines per inch, 8 lines per inch, 10 lines per inch, 12 lines per inch or 16 lines per inch.

In double cut mode, a second cross-cut is made at any interval of between 1 to 9 lines after the first cut as set by the digital coding switch.

## TECHNICAL DATA

### Basic Design:

The standard machine comprises the operator's panel, 2 tractor units with width adjustment by hand wheel, LH & RH edge (margin) trimmers, noise absorbing protective cover, & paper guides.

### EMC Conformity:

The electrical equipment incorporated in this machine with EMC Directive (89/336/EEC amended by 91/236/EEC and 92/31/EEC), TUV Rheinland Certification & CE Certification.

### Finish:

Spedo white main frame with graphite grey operator panel.

### Modes of Cut:

Normal single cut or double (strip) cut.

### Paper Weight:

Single Web: 40 g/m<sup>2</sup> to 360 g/m<sup>2</sup>.  
 Multipart Set: 90 g/m<sup>2</sup> - 400 g/m<sup>2</sup> max.

### Performance:

Form Depth	S/Cut	1/6 Strip Cut	Twin cut
14 inch	22,320	14,880	
12 inch	24,480	15,840	19,680
11 inch	25,920	16,440	
10 inch	27,480	17,040	
8 inch	31,080	18,360	
7 inch	32,760	19,080	
6 inch	35,400	20,040	
4 inch	42,000	21,120	
3 inch	42,120	21,240	

### Line Feed Increments:

1/6 in, 1/8 in, 1/10 in, 1/12 in, 1/16 in or millimetres

### Form Width:

90 mm - 520 mm

### Form Depth:

1/16 inch - 166 1/2 inch

### Strip Cut:

1/16 inch - 1 1/2 inch



**Width of Continuous Web:**

With carrier strip:	475 mm
Without carrier strip:	510 mm

**Feed Speed:**

Rotary control, continuously adjustable.

**Counter Type:**

Integrated multifunction batch and totalising counter.

**Power Requirements:**

Voltage:	230 V +/-10%
Frequency:	50 Hz to 60 Hz.
Power Consumption:	690 W (approx).

**Noise Emissions:**

74dB

**Dimensions:**

Length:	550 mm.
Width:	980 mm.
Height:	1070 mm.

**Weight:**

140 kg (approx).

**Options**

Options are listed in Appendix A1 to this section.

**DESCRIPTION OF OPERATION****Spedo 2500 Forms Cutter**

Paper is fed into the machine under the paper tension brush, over the in-feed plate, along the paper supports onto two tractor units. Once the tractor units have been adjusted for width and thickness (weight) of paper web, the web is 'jogged' forward and backwards by the operator until it has been aligned with the datum marks on the tractor unit flaps.

At this stage, if the carrier sides (margins) are to be cut off, LH and RH trimmers can be engaged, their precise position being set by aligning their cut marks with the carrier perforations. In addition, a centre cutter can be engaged and aligned by the operator at this point, if required.

The machine is capable of operating in conjunction with an ancillary unit (e.g. a web control, printer or collator) and successful co-operation between the two units depends on the loop of paper that forms between the two machines. The presence of paper feeding into the machine is detected by a paper runout switch located on the in-feed plate. If the paper runs out, the machine automatically stops.

### Operation with Spedo Web Control Units 970/971

When the machine is being supplied from a web control unit, and the in-fed paper is applied, a loop of paper forms between (Fig 2.1). The machine always controls its in-feed of paper from the web control. When the loop is low enough for the proximity sensor on the web control unit to detect its presence the web control unit is held stopped.

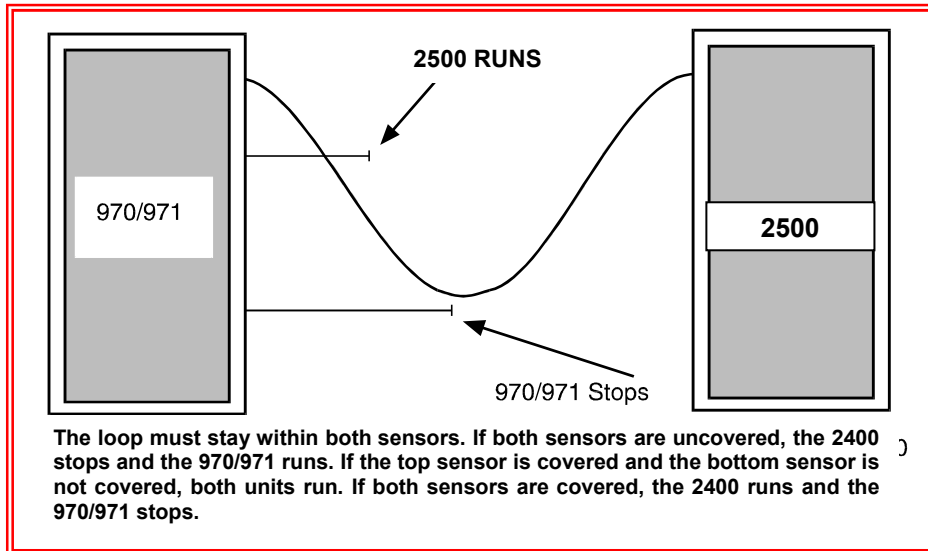

Fig 1.2 Loop Control - Web Control Units 970 & 971

As the machine continues to demand paper, the loop starts to rise. As the loop rises the photo cell on the web control unit will be cleared and the web control unit will start up until the loop falls far enough for the photo cell to detect it and so stop again. Note that the machine should always be set to run slower than the web control unit to maintain the loop.

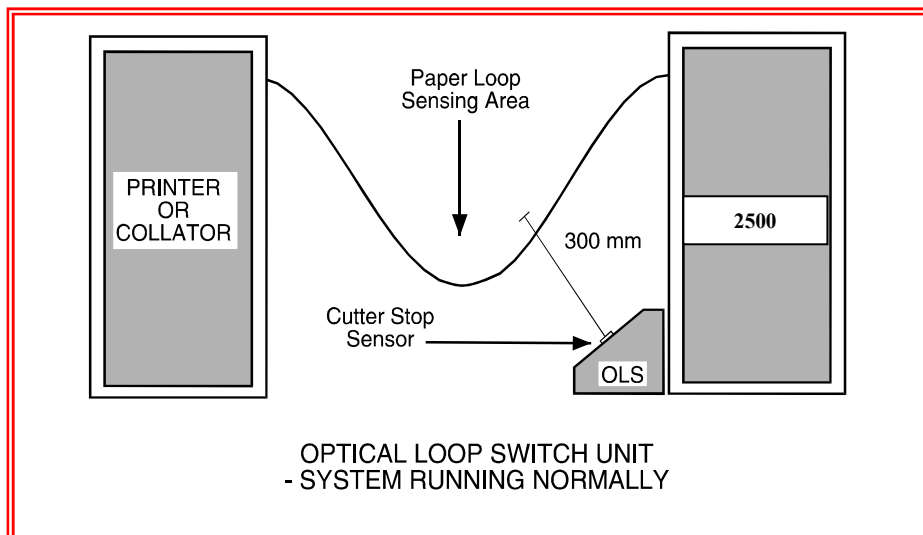
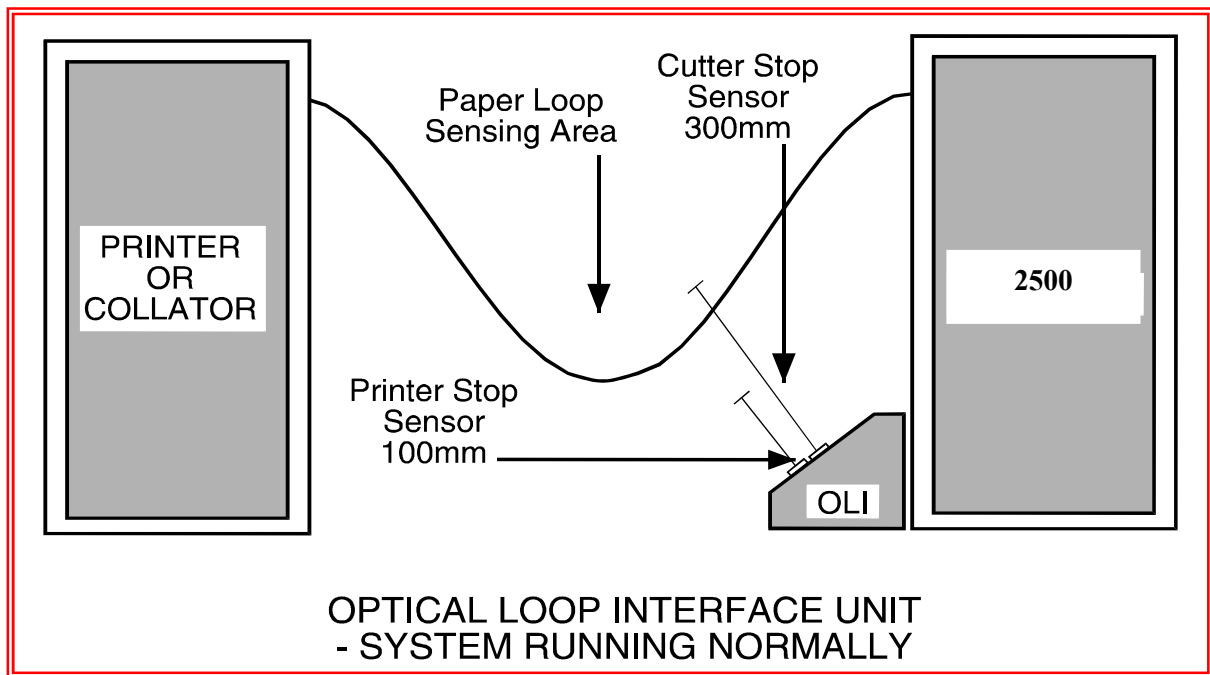

Fig 1.3 Loop Control - Optical Loop Switch unit

## Operation with a Printer or Collator

When the machine is being supplied from a printer or collator which has no means of controlling its out-feed, it will be necessary to control the paper loop height by positioning either a Spedo Optical Loop Switch Unit or an Optical Loop Interface Unit between the machine and the printer or collator as shown in Figs 1.3 & 1.4. Both Optical Loop units are available from Spedo UK Ltd.

Mains power is supplied to these units from the machine. The Spedo machine includes a synchronisation input facility that accepts an input connection lead from either optical loop unit. This must be connected so that the loop height can be automatically controlled.



**Fig 1.4 Loop Control – Optical Loop Interface Unit**

Detailed information on both loop control units is supplied in the relevant instruction manuals.

## MODES OF CUT

### Introduction

Forms can be cut either by a single cut or by a dual (double) cut as configured by the digital coding switch. The terminology used in the following explanation relates to Fig 1.5.

Single cut mode is used when it is required to make the cut at the perforation line on a paper web or from a paper reel as shown. The value of form depth is set on the digital code switch on the control panel.

Dual cut mode is used when the cut form depth required is smaller than the depth between perforations or when it is just required to cut out the perforation lines as shown below.

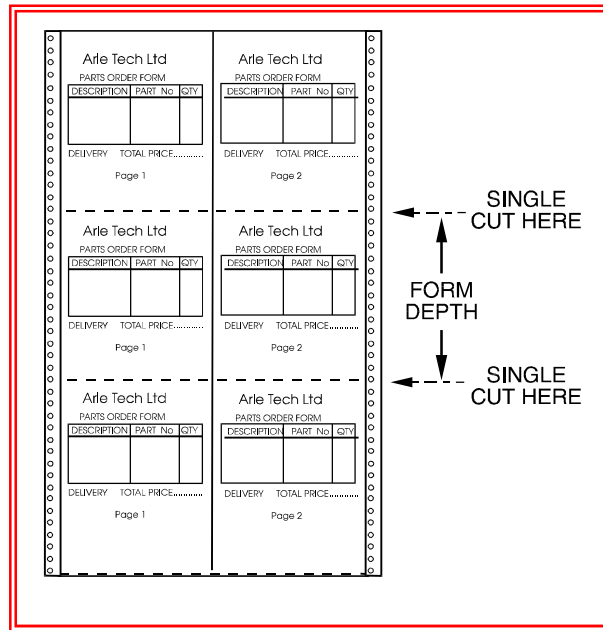

### Modes of Cut - Single Cut

As can be seen, this results in a strip being cut away between forms. In this mode, the value of the form depth and the strip depth is set in on the digital code switch on the control panel.

### Setting the Form Depth

The principle of setting form depth is by line count. The machine motor is geared such that 1 revolution of the tractor belt moves the paper web forward exactly 6 inches.

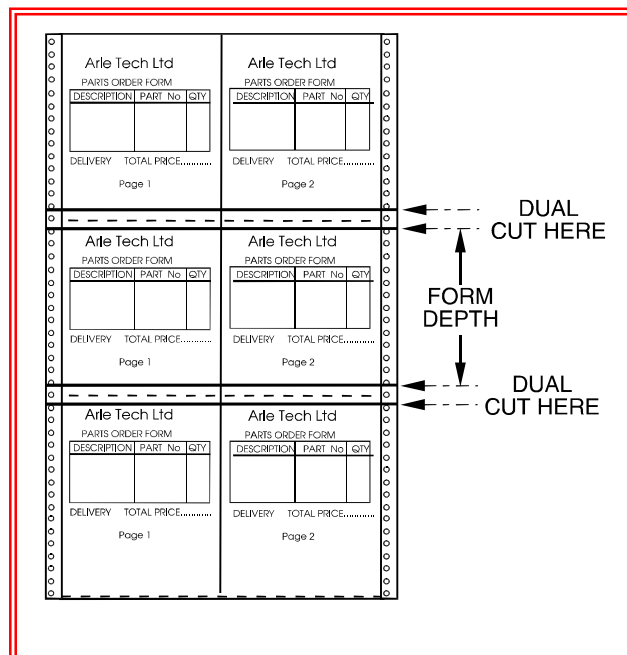

### Modes of Cut - Dual Cut

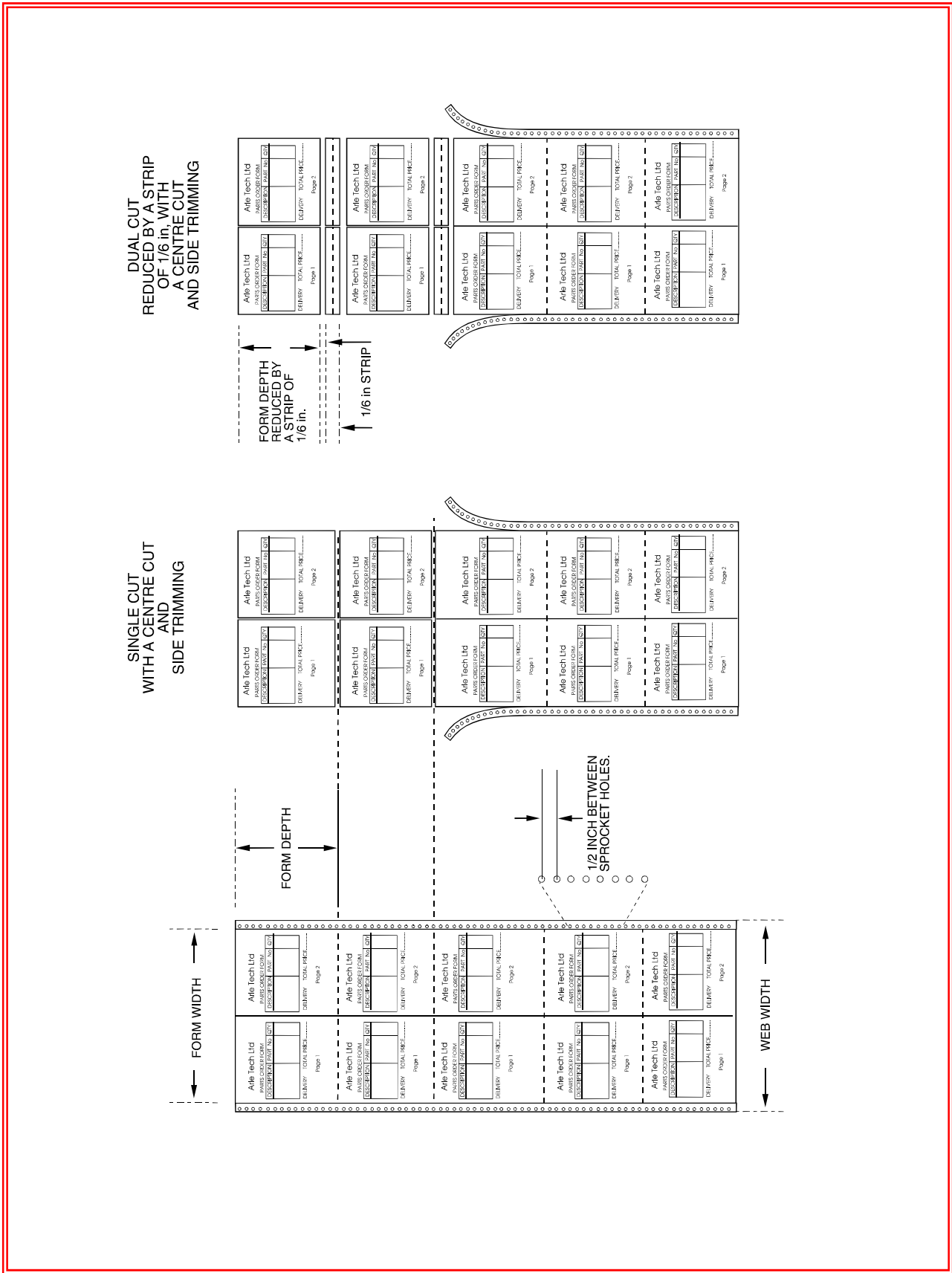

Fig 1.5 Modes of Cut

For single cut mode, the Strip Depth switch is always set to 0 and can be ignored during the following explanation.

In order to allow the operator to set various form depth values (6, 12, 18 inches) by line increment, the machine is fitted with a line increment feature that allows the cut to be made at line positions. The incremental values can be selected at the Increment switch and are as follows:

1/6 in	=	6 lines per inch
1/8 in	=	8 lines per inch
1/10in	=	10 lines per inch
1/12 in	=	12 lines per inch
1/16 in	=	16 lines per inch

From the above table, it can be seen that if you wished to cut to a form depth of 12 inches, if you selected a line increment of 1/6 in, this would be 6 lines x 12 inches = 72 lines. So you would dial up 072 on the Form Depth switch. The machine would then cut at each 72 line point.

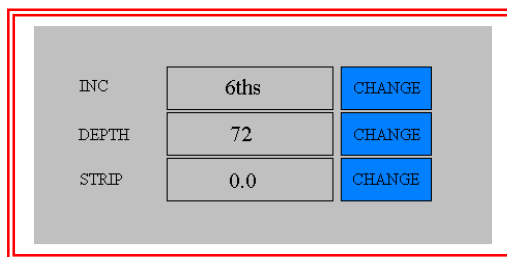

Similarly, if you selected 1/8 in line increment, this would be 8 lines x 12 inches = 96 lines. So you would dial up 096 on the Form Depth switch and the machine would then cut at each 96 line point and still maintain the 12-inch form depth.

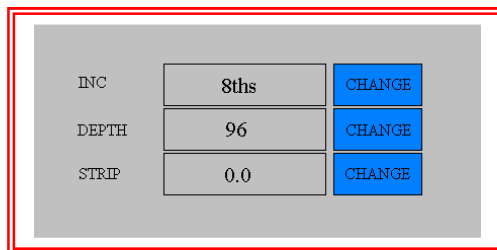

**Example 1.** If you wished to cut a form of depth 11<sup>1</sup>/<sub>4</sub> inches from a continuous paper web, the line increment set-in must be a multiple of the denominator of the fractional value (in this example it is 4). 4 is a multiple of 8, 12 or 16, so either of these incremental values can be set to give a round number of total lines per form depth:

With 1/8 in selected = 8 lines per inch,

$$8 \times 11 = 88$$

$$8/4 = 2 \text{ lines}$$

$$88 + 2 = 90 \text{ lines.}$$

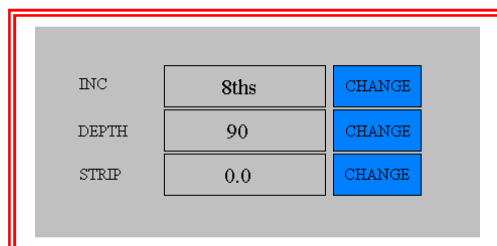

The values set on the digital code switches would be 8 090.

With 1/12 in selected = 12 lines per inch,

$$12 \times 11 = 132 \text{ lines}$$

$$12/4 = 3$$

$$132 + 3 = 135 \text{ lines}$$

INC	12ths	CHANGE
DEPTH	135	CHANGE
STRIP	0.0	CHANGE

The values set on the digital code switches would be 12 135.

With 1/16 in selected = 16 lines per inch,

$$16 \times 11 = 176 \text{ lines}$$

$$16/4 = 4$$

$$176 + 4 = 180 \text{ lines}$$

INC	16ths	CHANGE
DEPTH	180	CHANGE
STRIP	0.0	CHANGE

The values set on the digital code switches would be 16 180.

**Example 2.** If you wished to cut a form of depth 10 1/2 inches from a continuous paper web, the line increment set-in must be a multiple of the denominator of the fractional value (in this example it is 2).

2 is a multiple of 6, 8, 12 or 16, so either of these incremental values can be set to give a round number of total lines per form depth:

With 1/6 in selected = 6 lines per inch,

$$6 \times 10 = 60 \text{ lines}$$

$$6/2 = 3$$

$$60 + 3 = 63 \text{ lines}$$

INC	6ths	CHANGE
DEPTH	063	CHANGE
STRIP	0.0	CHANGE

The values set on the digital code switches would be 6 063.

With 1/8 in selected = 8 lines per inch,

$$\begin{aligned} 8 \times 10 &= 80 \text{ lines} \\ 8/2 &= 4 \\ 80 + 4 &= 84 \text{ lines.} \end{aligned}$$

INC	8ths	CHANGE
DEPTH	084	CHANGE
STRIP	0.0	CHANGE

The values set on the digital code switches would be 8 084.

With 1/10 in selected = 10 lines per inch,

$$\begin{aligned} 10 \times 10 &= 100 \text{ lines} \\ 10/2 &= 5 \\ 100 + 5 &= 105 \text{ lines.} \end{aligned}$$

INC	10ths	CHANGE
DEPTH	105	CHANGE
STRIP	0.0	CHANGE

The values set on the digital code switches would be 10 105.

With 1/12 in selected = 12 lines per inch,

$$\begin{aligned} 12 \times 10 &= 120 \\ 12/2 &= 6 \\ 120 + 6 &= 126 \text{ lines.} \end{aligned}$$

INC	12ths	CHANGE
DEPTH	126	CHANGE
STRIP	0.0	CHANGE



The values set on the digital code switches would be 12 126.

With 1/16 in selected = 16 lines per inch,

$$\begin{aligned} 16 \times 10 &= 160 \text{ lines} \\ 16/2 &= 8 \\ 160 + 8 &= 168 \text{ lines.} \end{aligned}$$

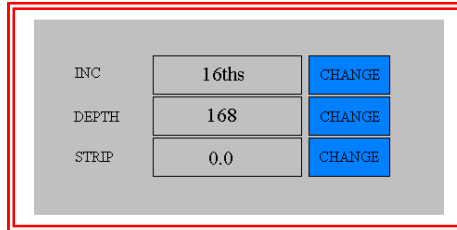

The values set on the digital code switches would be 16 168.

**Example 3.** If you wished to cut a form of depth  $7 \frac{1}{5}$  inches from a 12-inch continuous paper web, the line increment set-in must be a multiple of the denominator of the fractional value (in this example it is 5).

5 is a multiple of 10, so only an incremental value of 10 can be set to give a round number of total lines per form depth:

With 1/10 in selected = 10 lines per inch,

$$\begin{aligned} 10 \times 7 &= 70 \text{ lines} \\ 10/5 &= 2 \\ 70 + 2 &= 72 \text{ lines.} \end{aligned}$$

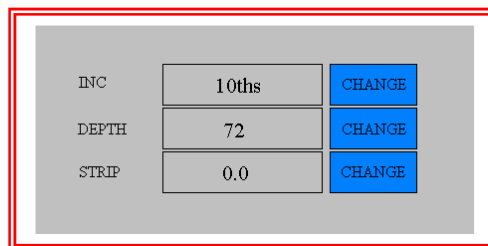

The values set on the digital code switches would be 10 072.

### Setting the Strip Depth in Dual Cut Mode

When in dual cut mode, the machine makes a cut immediately before and after a perforation, resulting in a strip being cut out. The strip depth value is set in terms of line increment on the Strip Depth switch.

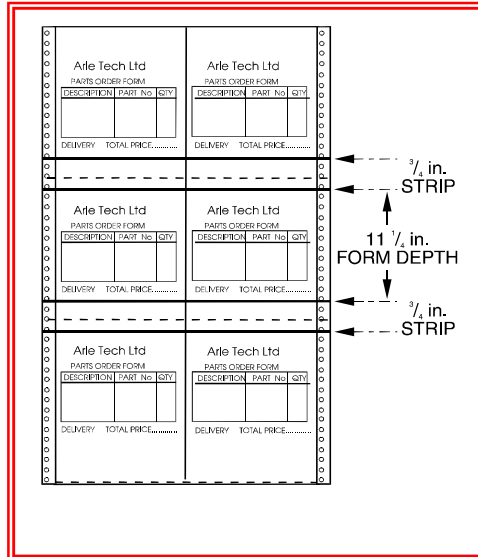

Consider Example 1 again. A form depth of 11 1/4 is to be cut from a 12-inch web:

$$12 - 11 \frac{1}{4} = \frac{3}{4}$$

This means that a 3/4 inch strip must be cut out between forms. A 3/4 inch depth at a line increment of 1/8 in works out as|:

$$\begin{aligned} 8/4 &= 2 \\ 2 \times 3 &= 6 \text{ lines.} \end{aligned}$$

With the value 6 set on the Strip Depth switch, 6 must be deducted from the original value of 90 set in for a single cut, so that 84 is now set-in on the Form Depth switch.

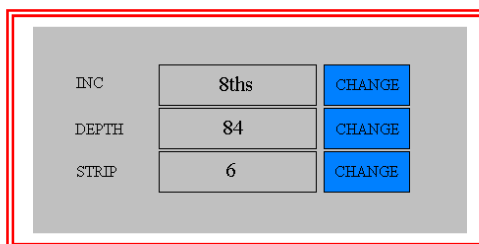

The Strip Depth switch can be set in the range 0 to 9 (lines) and these will relate to the line increment setting selected.

The cut positions can now be 'fine tuned' by the using the JOG pushbuttons to determine how many lines before and after the perforation line the cuts are made ( i.e., 3 lines before and 3 lines after, or 1 line before and 5 lines after, etc.)

## OPTIONAL ACCESSORIES

## APPENDIX A1

### Double Cross-Cut Blade

This is a cross-cutting device for removing the cross perforation from the paper web, without any loss of time or performance. The strip depth is 1/6 in and should be used with Conveyor Stacker Series 954. The strip is cleanly separated from the forms on each motion of the blades by blown air. The movable lower blade can be tilted off for single cut operation, if required. In this mode, the Strip Depth switch on the control panel can be used in the normal way.

### Optical Loop Switch Unit 2230

This unit is designed to control the height of the paper loop which forms between an outfeeding printer or collator and the associated in-feeding Spedo Forms Cutter.

### Optical Loop Interface Unit 2232

This unit is designed to control the height of the paper loop that forms between an out-feeding printer or collator and the associated in-feeding Spedo Forms Cutter. It also detects the overflow of paper out-feeding from the printer or collator that occurs if the Forms Cutter stops accepting paper infeed.

### Web Control Units 9700E

These units are part web separators for sequencing pages.

### Side Strip Chopper

This is used for shredding the cut-off side strip which is collected in a metal tray.

### Optical Mark Recognition

When fitted the Optical Mark Recognition Sensor (OMR) can be programmed to detect a MARK printed in a specific location on the form. Once the MARK has been registered by the sensor the cutter will perform a customer defined function. This could be a pause of a predetermined length or an output pulse / signal to an ancillary device.

### Anti Static Waste Paper Container SP180

This is supplied with mounting accessories for the side stripper chopper option.

### Centre Cutters

A Centre Cutter Assembly can be fitted, so providing additional longitudinal cuts along the paper web.

### Additional Accessories

- Stack Tray & Paper Stops

## RESIDUAL CURRENT DEVICE

## APPENDIX A2

### USE OF RESIDUAL CURRENT DEVICE (RCD)

As part of its highly reliable cutting mechanism, the Spedo 2500 Forms Cutter uses brushless AC servomotors. These servomotors use a high frequency switching current. If it is necessary to use a Residual Current Device with your system, it must be a unit that has been specified for inverter use.

Spedo UK recommends that only RCDs provided by Spedo UK are used. Spedo UK will not accept any responsibility for a system failure if an RCD from another supplier is used.

Two versions are available:

- Part No. SP005 376 Residual Current Device, c/w Cord Set.
- Part No. SP005 377 Residual Current Device, Wall Mounted.

## COMMISSIONING THE SYSTEM

## SECTION 2

### INTRODUCTION

The procedures given in this section should only be carried out by a competent trained service technician. Once the forms cutter has been declared ready to operate, the operating personnel should be made familiar with its safe operation.

### UNPACK

- Unpack the equipment and examine it thoroughly to ascertain whether any damage has occurred in transit.
- Report immediately any such damage to the agent or manufacturer. Retain the packing should further transportation be necessary.

### ACCESSORIES

The following items are supplied as standard:

- Operators Manual

### SITE CONSIDERATIONS

For optimum use of the forms cutter with an ancillary unit, the distance between them should be at least 3 feet up to a maximum of 8 feet. If heavy weight paper is to be cut, the maximum possible distance should be allowed.

Consideration must also be given to the layout and positioning of work tables and cupboards surrounding working area, at the same time leaving enough space around the system for the operator to have access to all operational requirements.

The forms cutter should be set square in relation to any ancillary unit.

If an ancillary unit is to be used with the forms cutter, refer to the relevant instruction manual, before making up the combined system.

### INSTALLATION

#### Connecting the Mains (Power) Lead

Connect the power lead to a plug suitable for the local power source. The colour codes are as follows:

- L (live) = BROWN wire
- N (neutral) = BLUE wire
- E (earth / ground) = GREEN/YELLOW wire.

Connect the power lead into the local power source socket.

#### Installation Checks

**WARNING:** Never operate the forms cutter when wearing items of loose clothing or other decorative jewellery, such as necklaces or bracelets as they could become entrapped in the machinery and cause injury.

- Note: If there is a delay of greater than 1 minute in moving between steps in the following procedure, the forms cutter goes into 'sleep mode'. To return to normal operation, hold down the START button for at least 2 seconds.
- The first time that the cross-cutting blade is to be actuated, it must only be carried out manually by a Spedo trained technician.
- Connect the machine to the local mains supply. Switch ON and check that the STOP and START pushbuttons illuminate. Close the protective cover.
- Set the digital coding switch to 6 035 1. Press the START pushbutton once. The STOP pushbutton should extinguish.
- Press the Line Advance pushbutton, so that the feed shaft rotates until the groove on the shaft is clearly visible, as shown in Fig 2.1.
- Press the In Feed pushbutton 6 times and check that the feed shaft rotates 6 times, returning to its original position.
- Press the Manual Blade pushbutton and check that the blade motor fires once per press.
- Press the START pushbutton once. Check that the feed shaft rotates one complete revolution and that the blade motor fires twice (dual cut). Check that the feed shaft has returned to its original position.
- Hold down the START button and check that the machine runs continuously.
- Place a sheet of paper under the paper tension brush, so as to cover the paper run out switch.
- Press the Continuous pushbutton once. Check that it has locked in position and that it has illuminated.
- Press the START pushbutton once. Check that the machine now cycles continuously with the feed shaft rotating one complete revolution, returning to its start point, and the blade firing twice (dual cut).
- Check that this cycle is repeated until either the STOP is pressed or the Continuous pushbutton is pressed once and released.
- As a safety check, open the protective cover and check that none of the above steps can be activated. Check also that the side trimmer shafts are not rotating.
- Repeat the safety check above with the main door removed.
- Once satisfied that the forms cutter is operating satisfactorily, install any other ancillary equipment that is to form the system (all instruction manuals provided with Spedo equipment contain installation and operating instructions). Connect any system leads between the forms cutter and any ancillary units as necessary.
- Load the forms cutter with a paper web as shown in Fig 2.1 and align it as shown in Fig 2.2.
- Operate the combined system and check that it functions satisfactorily. Before handing over, ensure that the operating personnel are familiar with all operating procedures (as given in Section 3) and are aware of any safety hazards involved.

FEED THE WEB BETWEEN THE FIRST TWO BARS AND TIGHTEN THE PAPER GUIDES IN PLACE.

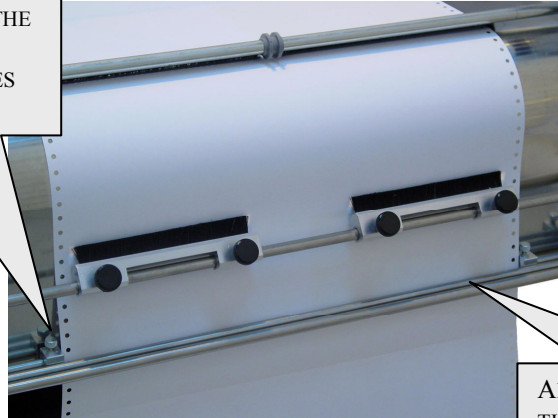

ALIGN THE INFEED BRUSHES AND TIGHTEN SO THAT THE PAPER IS HELD AGAINST THE INFEED PLATE.

OPEN TRACTOR FLAPS BEFORE IN FEEDING THE PAPER. ENGAGE PAPER ONTO THE TRACTOR SPROCKETS AND CLOSE TRACTOR FLAP.

ROTATE THE RED SPACERS CLOCKWISE TO DECREASE THE GAP OR ANTI-CLOCKWISE TO INCREASE THE GAP.

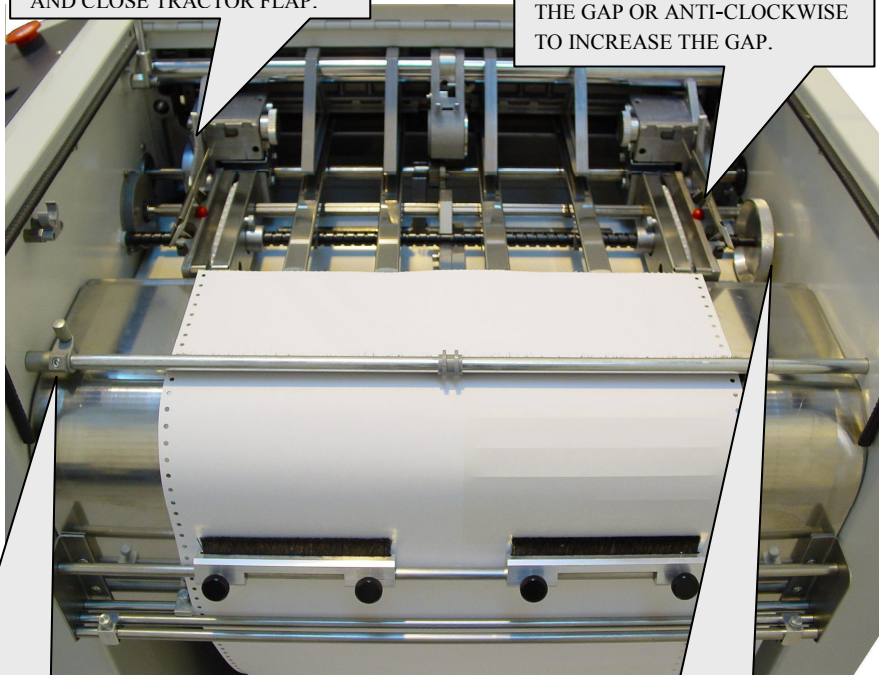

LIFT THE PAPER TENSIONER BAR AWAY FROM THE INFEED PLATE AND INSERT THE PAPER UNDER THE BAR. RETURN THE BAR TO ITS OPERATING POSITION.

ADJUST THIS HANDWHEEL TO INCREASE OR DECREASE THE WIDTH BETWEEN THE TRACTORS TO MATCH THE PAPER WEB WIDTH.

Fig 2.1 Loading the Paper Web

STEP 1. PRESS THE LINE ADVANCE BUTTON TO ALIGN THE LEADING EDGE OF THE PAPER WEB TO THESE DATUM MARKS.

STEP 2. USE THE FINE TUNE BUTTONS TO FINE TUNE THE LEADING EDGE OF THE PAPER WEB TO THE DATUM MARKS.

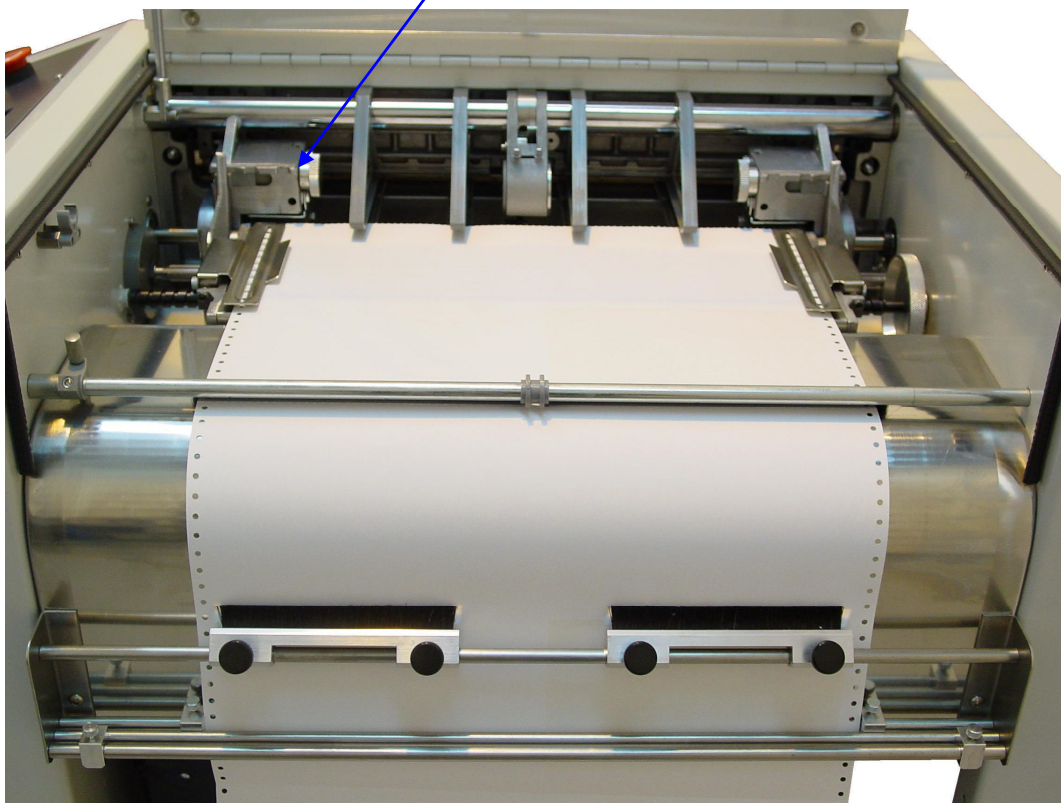
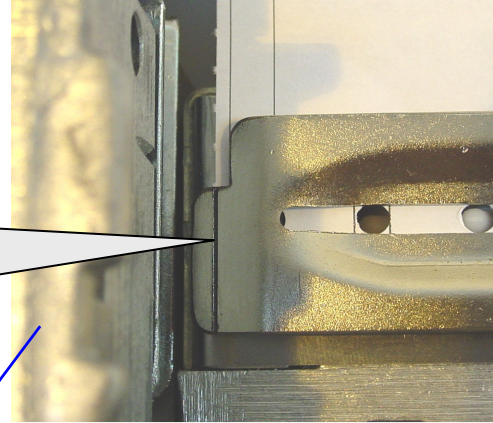

AFTER SETTING UP HAS BEEN COMPLETE, THE PAPER WEB SHOULD BE IN POSITION AS SHOWN ABOVE.



Fig 2.2 Aligning the Paper Web

## OPERATING INSTRUCTIONS

## SECTION 3

### SUMMARY OF CONTROLS

#### Paper Transport Deck

The major operational components of the paper transport deck are identified on Fig 3.1.

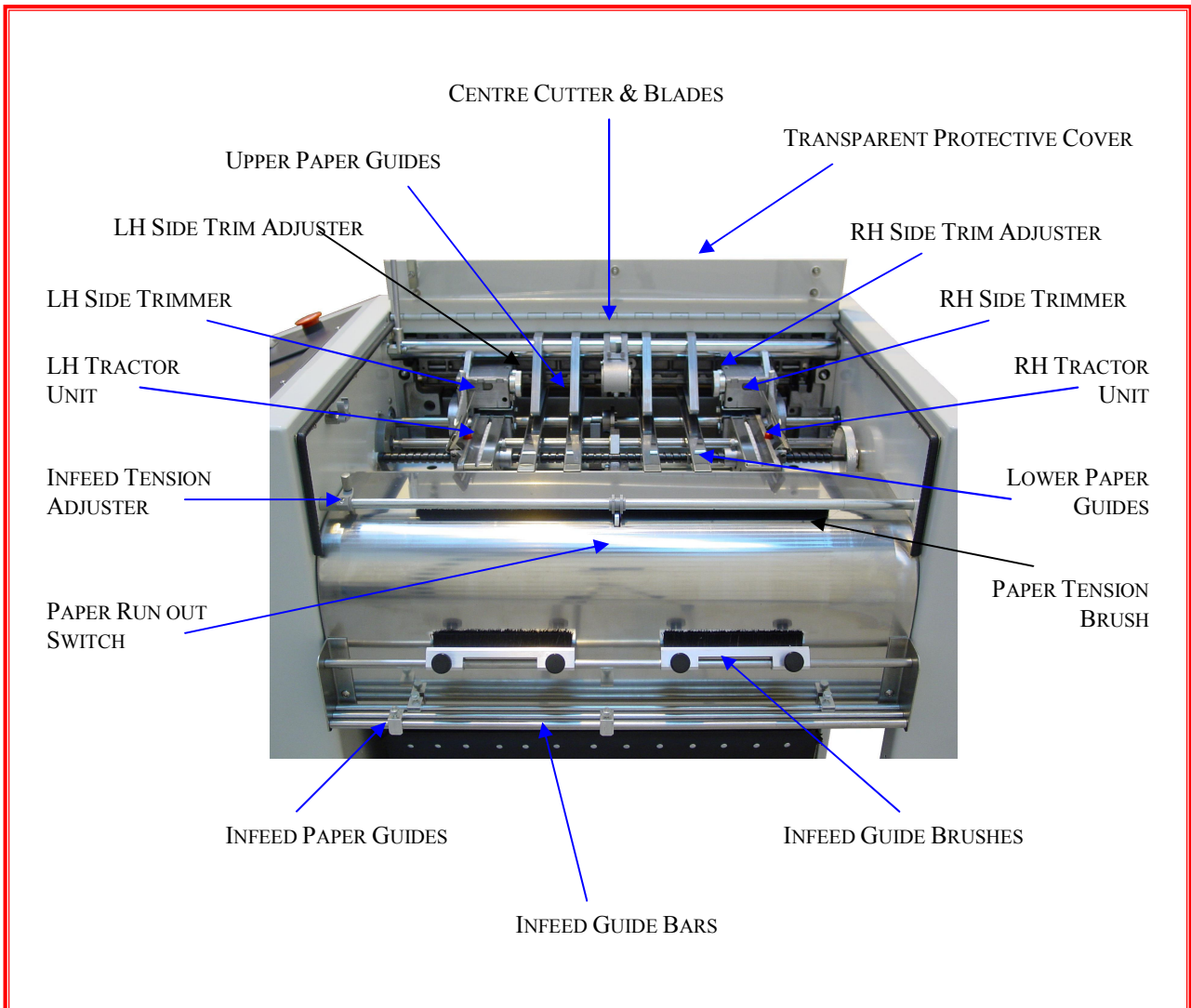

Fig 3.1 Summary of Controls - Paper Transport Deck

#### Control Panel

The guillotine is operated from the enhanced control panel. The controls are described under three main categories. Fig 3.2 gives a summary of pushbuttons and Fig 3.3 explains the use of the optional batch and total counters and the Speed Adjust slider control.

## OPERATING PROCEDURE

The following procedure is given as a general guide only, laying out a suggested order of setting up and operating the guillotine. It is essential that the operator is familiar with all the controls as summarised in the beginning of this section.

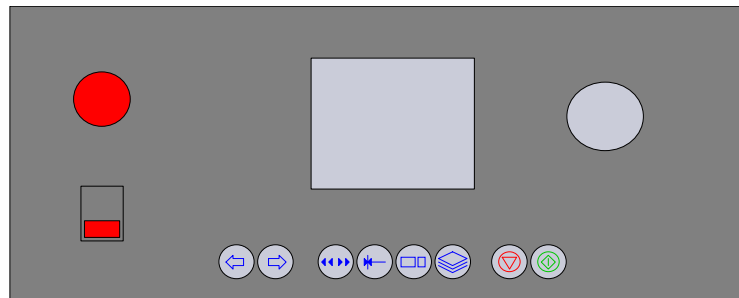

**OPERATOR PANEL**

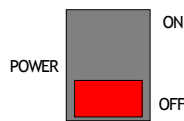

**POWER SWITCH**

Set this rocker switch to ON to apply power to the machine.

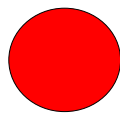

**EMERGENCY STOP SWITCH**

Hit this button to stop the cutter immediately.

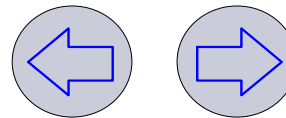

**FINE TUNE BUTTONS**

Press the JOG FORWARD and JOG BACKWARD buttons to fine tune the leading edge of the paper web.

**SET-UP BUTTONS**

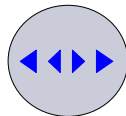

**LINE ADVANCE**

Press this button momentarily – the form advances one line.  
Press and hold this button – the form is moved continuously in the line increments.  
Press the STOP & LINE ADVANCE buttons simultaneously – the form moves back one line

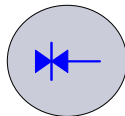

**IN-FEED**

Press this button to advance the leading edge of the web from the datum mark on the tractor flaps to the cutter blade.  
Press the STOP & IN-FEED buttons simultaneously to set the pause.

**MANUAL/CONTINUOUS BUTTONS**

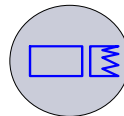

**MANUAL BLADE**

Press this button for a single cross cut.  
Press the STOP button & this button to select the NO CUT option.  
The BLADE button illuminates when active.

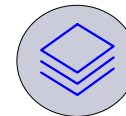

**CONTINUOUS**

Press this button for continuous operation of the cutter before the START button has been depressed.  
This is a latching button which illuminates when active.

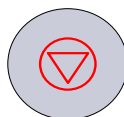

**STOP**

1. In Continuous mode this button interrupts the operation.  
2. If side trimming only is being performed (No-Cut operation), press this button to stop the operation.

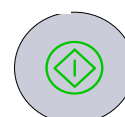

**START**

Once the Mode of Operation has been set-up, press this button to activate the process.

**Fig 3.2 Summary of Controls - Pushbuttons**

## Spedo Operator Panel Instructions.

**Initialisation.** – The following screen will be displayed for a few seconds while the cutter initialises.



### Opening Menu.

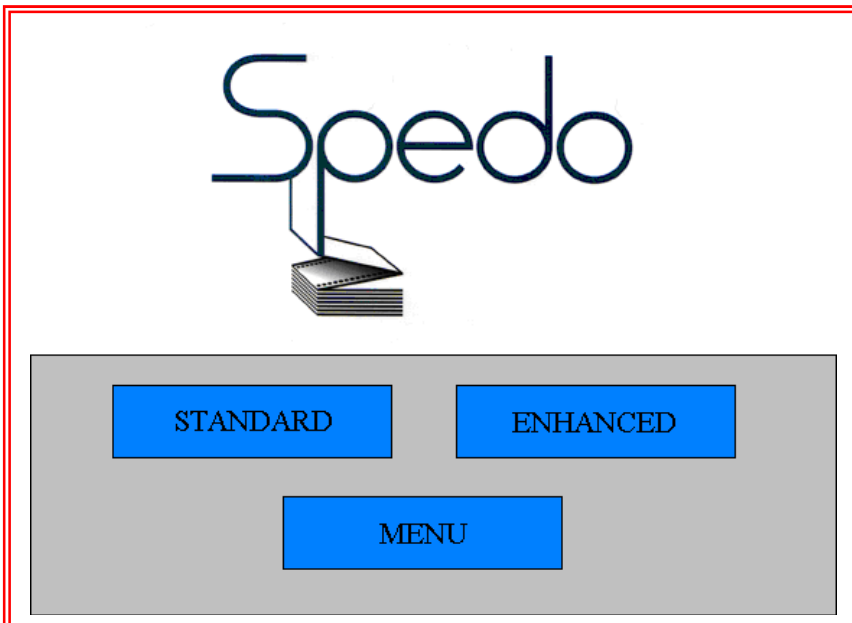

Select the required function from the opening menu.

**STANDARD** – Standard operation for single format forms.

**ENHANCED** - Enhanced mode for multi-format programmable jobs.

**MENU** – Menus for Advanced Functions, Maintenance and Parts Catalogue.

**STANDARD MODE:**

STANDARD		STANDARD	
TOTAL FORM LENGTH:		12.00 inches	
INC	6ths	CHANGE	
DEPTH	71	CHANGE	OMR SETUP
STRIP	1.0	CHANGE	B-MODE 1
			Pause 1.0s
			M-SPD 40
			Speed 40
OUTPUT	0 f/m		SET M-SPD
CHANGE	RST	4 COUNT	10 TARGET
			BACK

**Entering the page format.**

- Select Increment value using the CHANGE button the scroll through the options.
- Enter the Form Depth by pressing the CHANGE button and entering the value on the numeric keypad.
- Enter the Strip Depth by pressing the CHANGE button and entering the value on the numeric keypad.
- The combined value of the Form Depth and the Strip Depth is displayed at the top of the screen as TOTAL FORM LENGTH.

71_									
CANCEL		CLEAR						DELETE	
0	1	2	3	4	5	6	7	8	9
									.
								ACCEPT	

Above: Numeric Keypad.

### Changing the counter function.

- Enter the counter screen by pressing the CHANGE button in the bottom left hand corner of the screen.
- The Counter screen will now be displayed.

COUNTER & BATCH MODE SET -UP		
TARGET COUNT	10	CHANGE
CURRENT COUNT	4	RESET
BATCH MODE	1	CHANGE
MODE 1 TIME	1 Secs	CHANGE
MODE 2 TIME	0.5 Secs	CHANGE
MODE 3 TIME	0.5 Secs	CHANGE
MODE 4 TIME	1 Secs	CHANGE
Batch Mode: Normal Cutter: Pauses Mode 1 Time.		BACK

- Change the TARGET COUNT by pressing the CHANGE button and entering the required total into the numeric keypad.
- Reset the CURRENT COUNT by pressing the RESET button.

### Batch Mode Set-up.

Different batch modes can be set depending on the type of output device attached to the cutter.

#### BATCH MODE 1: Normal

This is the default batch mode; in this mode the cutter will pause for the time period selected in MODE 1 TIME (this is selected by using the CHANGE button to scroll through the different values).

Once the TARGET COUNT has been reached, the counter will be reset and the cutter will resume once the time period is over.

If the timer is set to 0 the cutter will stop once the target is reached, and will have to be restarted manually.

#### BATCH MODE 2: Conveyor Boost

This batch mode is used for boosting the 8500 Conveyor; in this mode the conveyor will be set to full speed for the time period selected in MODE 2 TIME (this is selected by using the CHANGE button to scroll through the different values).

Once the TARGET COUNT has been reached, the counter will be reset and the conveyor will resume once the time period is over.

In this mode the cutter will not pause when the target is reached.

### BATCH MODE 3: Conveyor Boost

This batch mode is used for boosting the 8500 Conveyor; in this mode the conveyor will be set to full speed for the time period selected in MODE 3 TIME (this is selected by using the CHANGE button to scroll through the different values).

At the same time as the conveyor is boosted the cutter will also pause for the same period of time. Once the TARGET COUNT has been reached, the counter will be reset and the conveyor and the cutter will resume once the time period is over.

### BATCH MODE 4: 3<sup>rd</sup> Party Dropping Stacker

This batch mode is used for operation with a dropping stacker; in this mode the cutter will pause for the time period selected in MODE 3 TIME (this is selected by using the CHANGE button to scroll through the different values).

Once the TARGET COUNT has been reached, the counter will be reset and the conveyor will resume once the time period is over.

- Once the required batch mode and counter settings have been achieved return to the STANDARD MODE screen by pressing the BACK button.

### Setting the Maximum Speed (M-SPD)

It is possible to set the maximum speed of the cutter by using the SET M-SPD function on the operator screen. Press the SET M-SPD button and you will be asked to enter the supervisor password. This is set factory set to 123456 but can be changed in the engineering screen.

Please enter 6 digit Supervisors Code									
123456									
CANCEL		CLEAR						DELETE	
0	1	2	3	4	5	6	7	8	9
								ACCEPT	

Once the correct code has been entered you can now change the maximum speed setting between 0-100%.

Please enter Max Speed, range 1-100									
100									
CANCEL		CLEAR						DELETE	
0	1	2	3	4	5	6	7	8	9
								ACCEPT	

**Standard run mode.**

Press the green Start button and the editing functions will be removed from the screen.

STANDARD		STANDARD							
TOTAL FORM LENGTH:		12.00 inches							
INC	6ths	CHANGE							
DEPTH	71	CHANGE							
STRIP	1.0	CHANGE							
				B-MODE 1					
				Pause 1.0s					
				M-SPD 40					
				Speed 40					
OUTPUT	0 f/m			SET M-SPD					
	RST	4 COUNT		10 TARGET					

While the cutter is running in STANDARD mode the form length will be displayed along with the BATCH MODE status.

The cutter output is also displayed in the required format alongside the red speed indicator.

The counter can be reset at any time by pressing the RST button.

To return to the STANDARD mode set-up screen press the red Stop button.



## OPTICAL MARK RECOGNITION (OMR) SETUP:

With the OMR sensor option fitted various functions can be initialised. Press the OMR SETUP button to enter the OMR setup menu.

OMR SET-UP		
OMR STATUS	ON	CHANGE
MARK POSITION (mm)	10	CHANGE
WINDOW WIDTH (mm)	10	CHANGE
OMR MODE	1	CHANGE
OMR PAUSE TIME	1 Secs	CHANGE
OMR PULSE TIME	0.1 Secs	CHANGE
OMR pauses by PAUSE TIME IF PAUSE TIME = 0 Cutter stops		BACK

**OMR STATUS:** Turns the operation of the OMR sensor ON and OFF. Press the CHANGE button the toggle.

**MARK POSITION:** This is the distance from the leading edge of the form to the leading edge of the mark, measured in millimetres. Press the CHANGE button to enter the position of the OMR mark on the numeric keypad.

**WINDOW WIDTH:** This should be set the largest area of clear space around the mark; the sensor will only read within this area. Press the CHANGE button to enter the required viewing window size in millimetres.

**OMR MODE:** Selects the function of the cutter upon seeing the mark in the pre-set position. Press the CHANGE button to toggle through the different OMR modes.

**OMR MODE 1:** The cutter pauses by the OMR PAUSE TIME value when the marked form reaches position number 1. If OMR PAUSE TIME is set to 0 then the cutter will stop. Press the CHANGE button to toggle value.

**OMR MODE 2:** The cutter will pulse the OMR output by the OMR PULSE TIME value when the marked form reaches position number 1. Press the CHANGE button to toggle value.

### Running in OMR Mode:

OMR STATUS:		<input type="text"/>		<input type="text"/>		<input type="text"/>		<input type="button" value="OMR RESET"/>	
TOTAL FORM LENGTH:		12.00 inches							
OMR OFFSET		62 mm							
INC	<input type="text" value="6ths"/>	<input type="button" value="CHANGE"/>							
DEPTH	<input type="text" value="71"/>	<input type="button" value="CHANGE"/>						<input type="button" value="OMR SETUP"/>	
STRIP	<input type="text" value="1.0"/>	<input type="button" value="CHANGE"/>						<input type="button" value="B-MODE 1"/>	
								<input type="button" value="Pause 1.0s"/>	
								<input type="button" value="M-SPD 40"/>	
								<input type="button" value="Speed 40"/>	
OUTPUT	0 f/m							<input type="button" value="SET M-SPD"/>	
<input type="button" value="CHANGE"/>	<input type="button" value="RST"/>	<input type="text" value="4"/>		<input type="text" value="10"/>				<input type="button" value="BACK"/>	
		COUNT		TARGET					

Load the forms as normal ensuring the first form in the group is nearest the blade. Press the OMR RESET button to clear the OMR STATUS, any MARKED forms which are between the sensor and the blade will be ignored. Once this is done the job is ready to run.

OMR STATUS:		<input type="text"/>		<input checked="" type="text"/>		<input type="text"/>		<input type="button" value="OMR RESET"/>	
TOTAL FORM LENGTH:		12.00 inches							
OMR OFFSET		62 mm							
INC	<input type="text" value="6ths"/>	<input type="button" value="CHANGE"/>							
DEPTH	<input type="text" value="71"/>	<input type="button" value="CHANGE"/>							
STRIP	<input type="text" value="1.0"/>	<input type="button" value="CHANGE"/>						<input type="button" value="B-MODE 1"/>	
								<input type="button" value="Pause 1.0s"/>	
								<input type="button" value="M-SPD 40"/>	
								<input type="button" value="Speed 40"/>	
OUTPUT	0 f/m							<input type="button" value="SET M-SPD"/>	
	<input type="button" value="RST"/>	<input type="text" value="4"/>		<input type="text" value="10"/>					
		COUNT		TARGET					

As the MARK is read by the OMR sensor in the position entered on the OMR SETUP screen the location will be displayed in the OMR STATUS boxes in the top of the screen. (Each box represents 1 form between the sensor and the blade). When the MARKED form reaches position number 1 (nearest the blade) the cutter will perform the OMR MODE operation.

**ENHANCED MODE:**

ENHANCED		ENHANCED	
JOB LIST			
JOB	NAME	FORMS	
1	Test	5	<input type="button" value="^"/> <input type="button" value="v"/> <input type="button" value="EDIT"/> <input type="button" value="ADD"/> <input type="button" value="DELETE"/> <input type="button" value="SELECT"/> <input type="button" value="BACK"/>

**Adding a new job.**

To add a new job press the ADD button with which will take you to the JOB DETAILS screen.

ENTER JOB DETAILS		
NAME	---	<input type="button" value="CHANGE"/>
FORMS	0	<input type="button" value="CHANGE"/>
M-SPD	0	<input type="button" value="CHANGE"/>
Maximum NAME length = 20 letters Maximum number of FORMS = 10 M-SPD range 0 to 100%		
		<input type="button" value="BACK"/>

Enter the job name by pressing the CHANGE button and entering the name in the alphanumeric keypad.  
 Enter the number of forms by pressing the CHANGE button and entering the value on the numeric keypad.  
 Enter required max speed by pressing the CHANGE button and entering the value on the numeric keypad.  
 (Note: Supervisor code is required to change this.)  
 Press the BACK button the return to the enhanced job list screen.

### Deleting a job.

To delete a job on the JOB LIST screen use the up and down buttons to highlight the required job, then press the DELETE button which will take you to the delete job screen.

DELETE JOB - PLEASE CONFIRM?

NAME

FORMS

Press the YES button to delete the job or NO to return to the JOB LIST screen.

### Selecting and editing a job.

ENHANCED		ENHANCED	
JOB LIST			
JOB	NAME	FORMS	
1	Test	5	<input type="button" value="^"/> <input type="button" value="v"/> <input type="button" value="EDIT"/> <input type="button" value="ADD"/> <input type="button" value="DELETE"/> <input type="button" value="SELECT"/> <input type="button" value="BACK"/>

Using the up and down keys highlight the required job and press the SELECT button to open.

**Editing the forms.**

ENHANCED				ENHANCED
FORM	INC	DEPTH	STRIP	
1	6ths	36	0	^
2	8ths	190	2	v
3	10ths	60	0	EDIT
4	12ths	71	1	B-MODE 1
5	16ths	95	1	Pause 0.0s
OUTPUT 0 f / m				M-SPD 45
				Speed 45
CHANGE	RST	4	10	SET M-SPD
		COUNT	TARGET	BACK

Using the up and down keys highlight the required form and press the EDIT button to change each form length.

The job will always start from the highlighted form so remember to return the cursor to form 1 before running.

TOTAL FORM LENGTH:		12.00 inches
INC	6ths	CHANGE
DEPTH	71	CHANGE
STRIP	1.0	CHANGE
BACK		

**Entering the page format.**

- Select Increment value using the CHANGE button the scroll through the options.
- Enter the Form Depth by pressing the CHANGE button and entering the value on the numeric keypad.

- Enter the Strip Depth by pressing the CHANGE button and entering the value on the numeric keypad.
- The combined value of the Form Depth and the Strip Depth is displayed at the top of the screen as TOTAL FORM LENGTH.

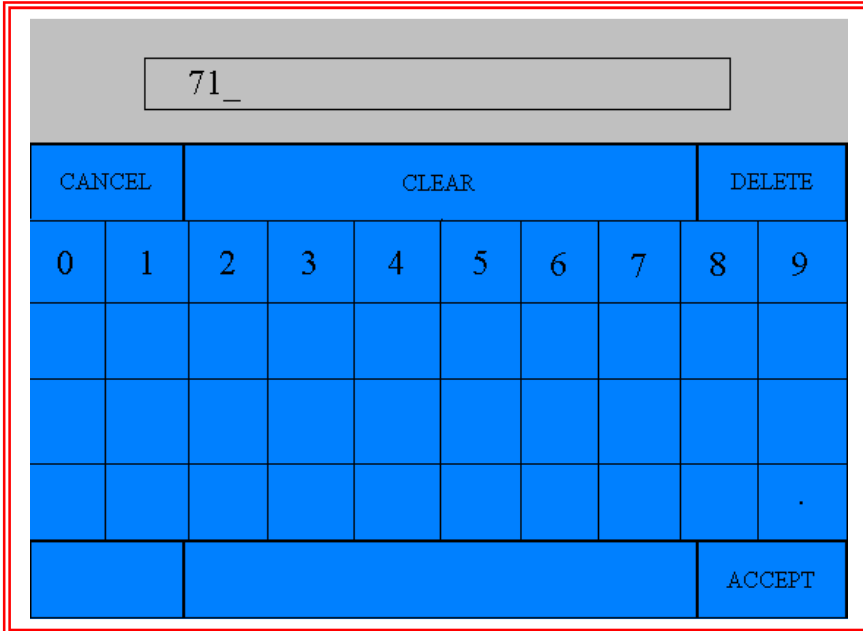

Above: Numeric Keypad.

**ENHANCED run mode.**

Press the green Start button and the editing functions will be removed from the screen.

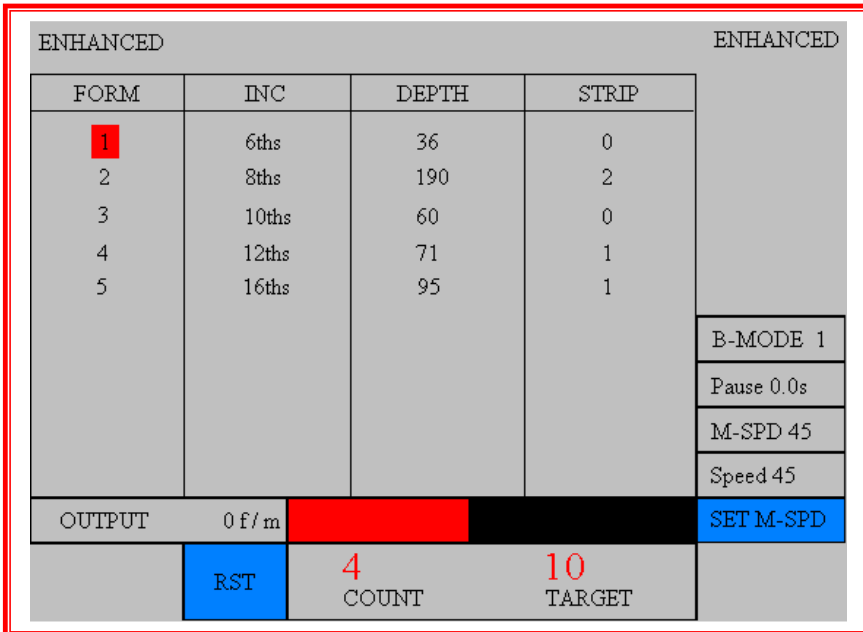

While the cutter is running in ENHANCED mode the form length will be displayed along with the BATCH MODE status.

The cutter output is also displayed in the required format alongside the red speed indicator.

The counter can be reset at any time by pressing the RST button.

To return to the STANDARD mode set-up screen press the red Stop button.

## MENU:

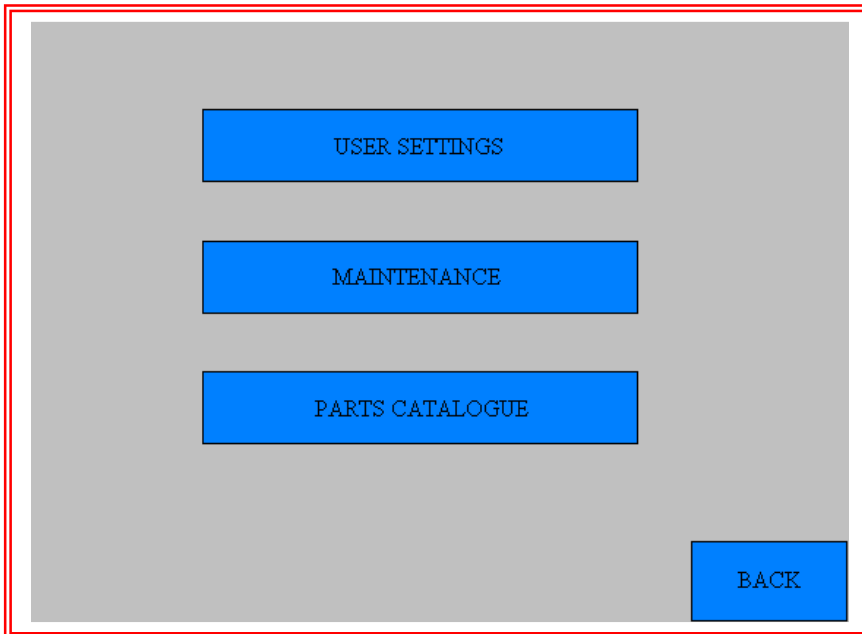

From the menu screen you can access the USER SETTINGS, the MAINTENANCE screens and the PARTS CATALOGUE.

## USER SETTINGS

### Page 1.

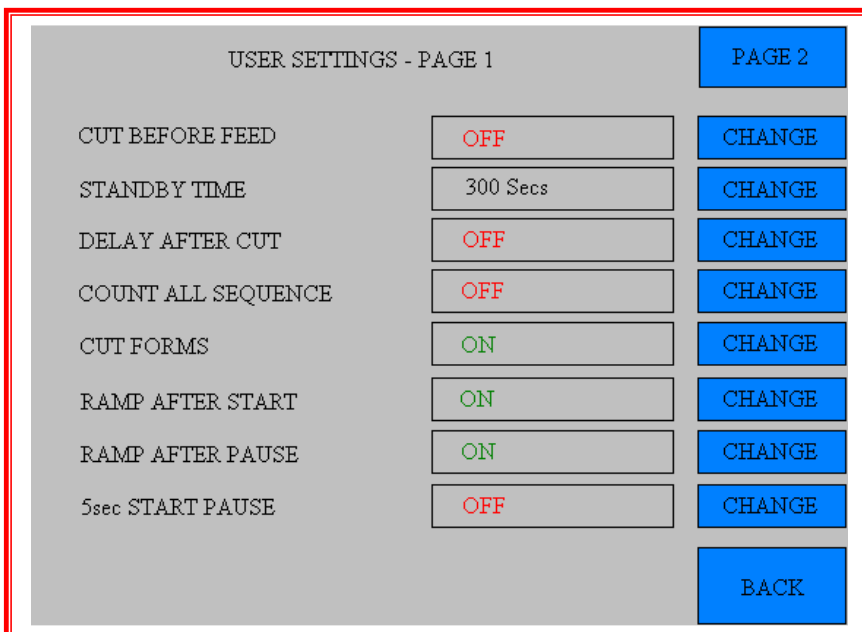

**CUT BEFORE FEED:** the operation of the cutter can be reversed. Press the CHANGE button to toggle the function ON / OFF.

**STANDBY TIME:** the time allowed until the machine enters standby mode can be adjusted. Press the CHANGE button to scroll through the options.

**DELAY AFTER CUT:** a small delay can be added after each cut. Press the CHANGE button to scroll through the options.

**COUNT ALL SEQUENCE:** this function allows either all forms within an enhanced job to be counted individually or the complete job to be counted as a whole. Press the CHANGE button to toggle ON / OFF.

**CUT FORMS:** this function allows the blade operation to be turned off. Press the CHANGE button to toggle ON / OFF.

**RAMP AFTER START:** this function allows the cutter to gradually increase in speed when started. Press the CHANGE button to toggle ON / OFF.

**RAMP AFTER PAUSE:** this function allows the cutter to gradually increase in speed when restarted from a pause. Press the CHANGE button to toggle ON / OFF.

**5sec START PAUSE:** this function adds a 5 second delay between the start button being pressed and the cutter running. Press the CHANGE button to toggle ON / OFF.

## Page 2.

USER SETTINGS - PAGE 2		
PAPER RUN OUT	ON	CHANGE
LANGUAGE	ENGLISH	CHANGE
SPEED FORMAT	M/Min	CHANGE
9300/9700 CONNECTED	NO	CHANGE
ANA0 CONNECTED	NO	CHANGE
		BACK

**PAPER RUN OUT:** this function allows the paper run out switch to be overridden. Press the CHANGE button to toggle ON / OFF.



**LANGUAGE:** This function allows different languages to be selected. Press the CHANGE button to toggle through the options.

**SPEED FORMAT:** This function allows performance to be displayed on the operator panel in feet per minute or metre per minute. Press the CHANGE button to toggle through the options.

**9300/9700 CONNECTED:** This function is used where speed control is required for controlling a Spedo 9400 Web Buffer in 9300 control mode or a Spedo 9700E Slitter Merger.

**ANA0 CONNECTED:** This function is enable when an external analogue sensor is connected.

### MAINTENANCE:

The screenshot shows a maintenance screen with a title 'MAINTENANCE' at the top. Below the title is a table with the following data:

MAINTENANCE	
TOTAL FORMS	12345
TOTAL CUTS	67890
CUTS SINCE LAST SERVICE	20000
Software Version:	14
Revision Date:	24th Feb 2011

At the bottom of the screen, there are two buttons: 'ENGINEER' on the left and 'BACK' on the right.

From the maintenance screen the following information can be viewed.

**TOTAL FORMS** – This is the amount of forms processed over the cutters life.

**TOTAL CUTS** – This is the amount of cuts the cutter has done over its life.

**CUTS SINCE LAST SERVICE** – This is the amount of cuts the cutter has done since the blades were last changed. This number can be reset in the ENGINEER screen.

**SOFTWARE VERSION** – This is the version number of both the operator panel and the control panel user software.

**ENGINEER mode**

To enter, press the ENGINEER button and enter the code on the numeric keypad.

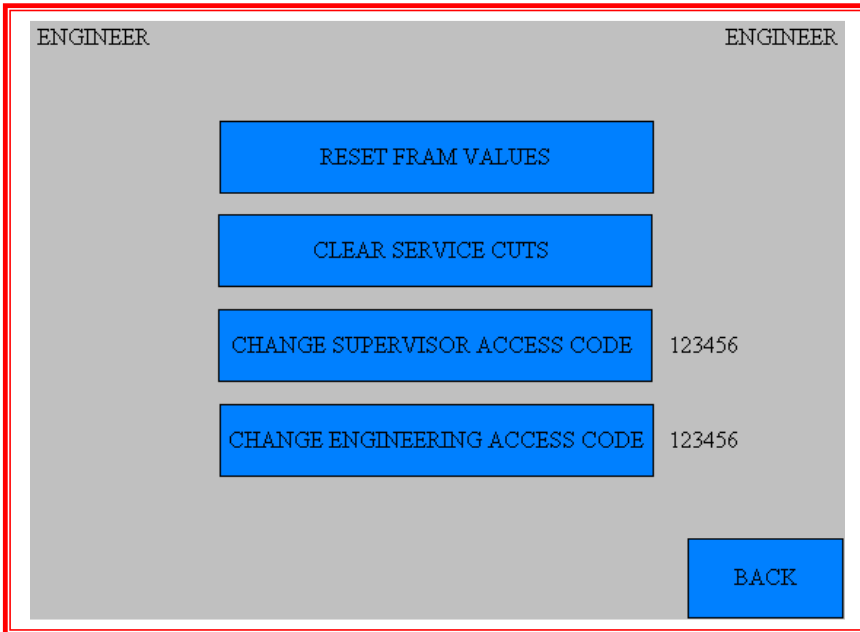

- Press RESET FRAM VALUES to reset all user parameters (batch values etc.)
- Press CLEAR SERVICE CUTS to reset CUTS SINCE LAST SERVICE to 0.
- Press CHANGE SUPERVISER ACCESS CODE to change the supervisor password, which is used for protecting the M-SPD values.
- Press CHANGE ENGINEERING ACCESS CODE to change the engineer’s password, which is used to access the ENGINEER screen.

**PARTS CATALOGUE:**

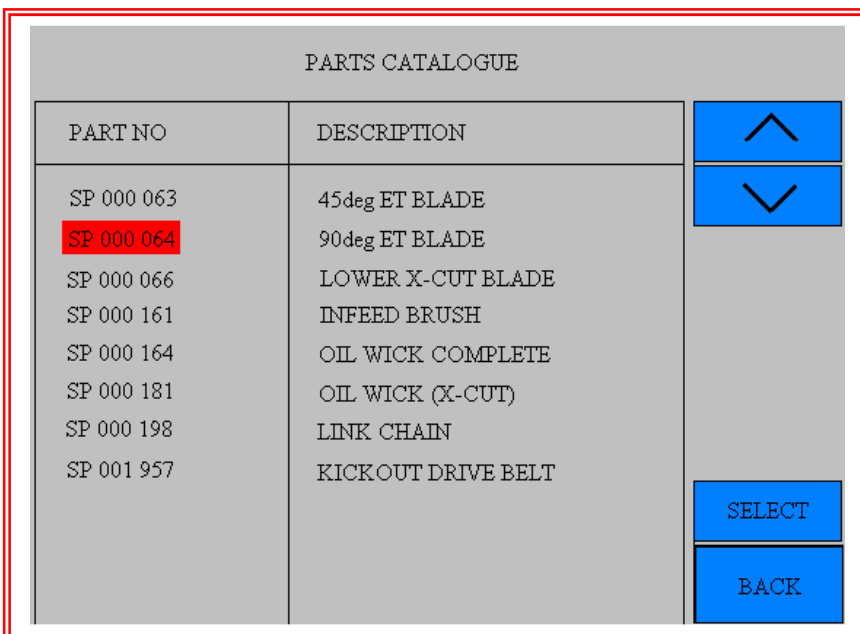

Using the up and down buttons highlight the required part number and press the SELECT button to view the highlighted component.



## WARNINGS

The putting into operation of the machine, especially the actuation of the cross-cut guillotine blade presupposes that the guillotine has been correctly installed by a Spedo trained technician. The manufacturer is not liable for damage caused by non-observance of the procedures given in this manual. Please observe the following precautions before switching on the cutter for the first time:

- Never wear items of loose clothing or other decorative jewellery, such as necklaces or bracelets as they could become entrapped in the moving parts of the machinery.
- Never touch the working area of the longitudinal cross-cut blade. This is applicable especially when standing at the stacker end, when the motor is running.
- If any malfunction occurs, contact the Customer Services Department of Spedo or their agent for assistance. DO NOT ATTEMPT to correct any mechanical malfunction that occurs.

## Paper Loading

- Select Standard or Enhanced Mode, as shown on Fig 3.5.
- Standard Mode. Select the required feed, form depth and strip depth using the on-screen digital coding keypad displayed on the touch panel.
- Enhanced Mode. Set up the job sequence and formats as described in Figs 3.5, 3.6 and 3.7.
- Switch on the MAINS switch. Check that the MAINS switch and the STOP switch have illuminated.
- Open the protective cover. Release the centre cutter away from the paper path.
- Open the in-feed tension brush and feed the paper web underneath it over the in-feed plate. Return the in-feed tension brush to its operating position.
- Pull enough length of paper web through so that it can lie unsupported on top of the paper supports.
- Set the space between the tractor units at approximately the required distance and position the paper clamps and paper supports at equal intervals between the tractor units.
- Open the tractor units flaps and pull enough length of paper through so that it now covers the tractor sprockets. Adjust the tractor units until the holes in the paper carrier strip engage onto the tractor sprockets.
- Close the tractor unit flaps and check that the space under the flaps is enough to cater for the weight (thickness) of paper web. If necessary, adjust the height of the RED adjusters until the flaps are at the required setting.
- With the flaps closed, adjust the space between tractor units so that the paper lies flat and is slightly tensioned across its width.
- Close the protective cover. Press the START pushbutton to extinguish the STOP pushbutton. Use the Line Advance pushbutton to align the leading edge of the paper web with the datum marks on the tractor unit flaps. Use the JOG pushbuttons to 'fine tune' the alignment

- If side trimming is required, open the protective cover and slide the side trimmer(s) so that the trimmer block(s) engage with the tractor unit(s), (position 3 as shown on Fig 3.9). Align the yellow cut mark with the side carrier cut line.
- If a centre cut is required, engage the centre cutter and adjust its position to align with the centre cut mark on the paper web, as shown in Fig 3.8. Close the protective cover. Press the START pushbutton to extinguish the STOP pushbutton.
- Set the batch counter as required. A pause facility has been incorporated to allow automatic batching of form sets without the need for operator intervention.
- The cutter is now ready to be operated. However, before starting, ensure that a paper loop has formed between the in-feeding ancillary unit (if present) and the guillotine and that the loop will be automatically controlled by the system.

### Operation from the Control Panel

The paper transport deck as set up above applies to single cut mode. If a dual strip cut is required to be made according to the digital cut mode keypad, the leading edge of the paper web on the first form to be fed through, can be advanced past the datum marks on the tractor flaps by further use of the JOG pushbuttons.

Having set the guillotine as required above, proceed as follows:

#### Preliminary Manual Cut Operation

- Press the START pushbutton. Check that the RED STOP pushbutton has extinguished.
- Press the In-Feed pushbutton and check that the leading edge of the paper web advances to the guillotine blade.
- Press the Manual Cross-Cut pushbutton and check that the guillotine blade cuts across the full width of the paper web.
- Press the START pushbutton a few times to produce some cut forms and check the forms for correct cut position and depth. Fine tune the cut position using the JOG pushbuttons.
- It may also be necessary to re-adjust the side trimmers and the centre cutter positions at this time.
- Set the stacking guides and paper stops according to the position and size of the cut forms.
- Start Continuous Operation as detailed below, if required.

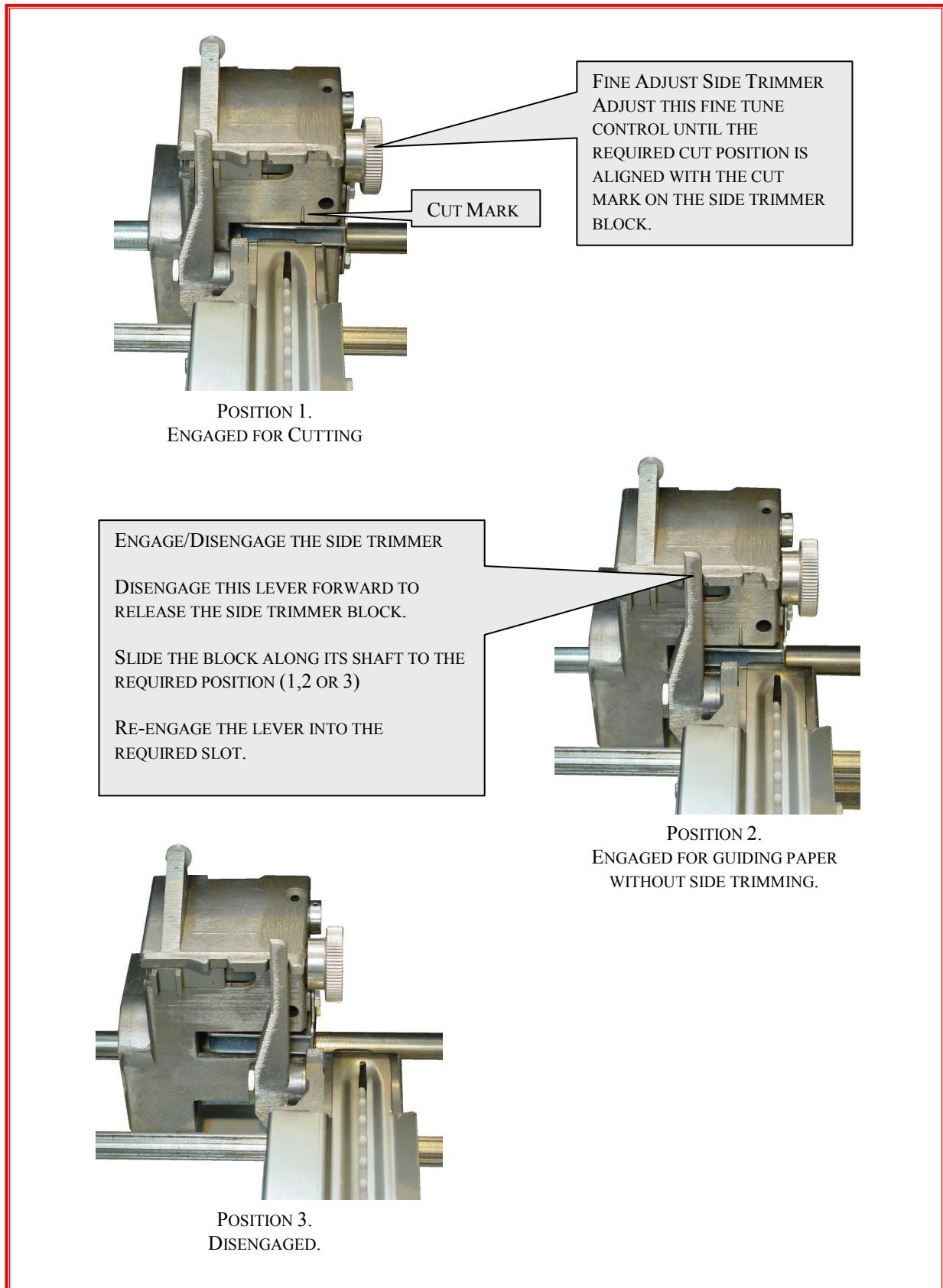

**Fig 3.8 Setting the Side Trimmers**

RAISING/LOWERING THE CENTRE CUTTER BLOCK.  
TO RELEASE THE CENTRE CUTTER BLOCK, DEPRESS THIS LEVER  
DOWNWARDS AND MOVE CENTRE CUTTER TO THE REQUIRED POSITION.

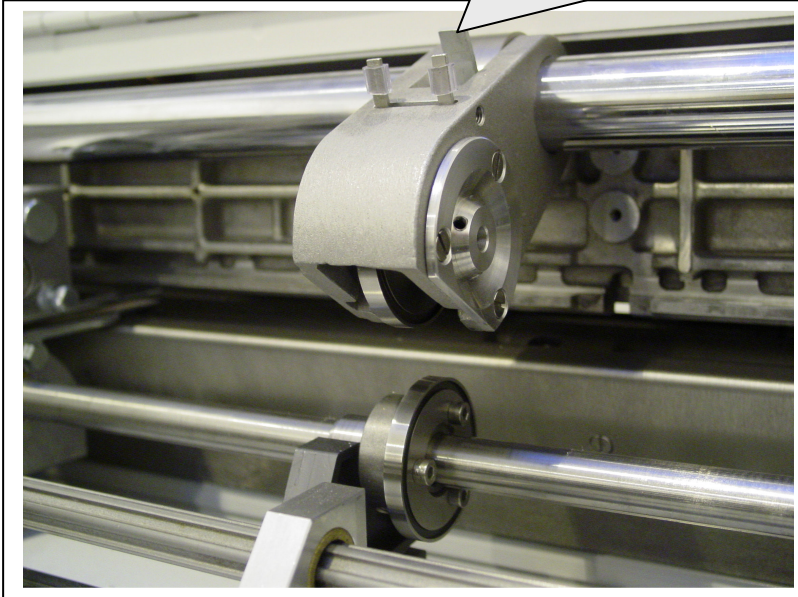

ENGAGING FOR RIGHT SIDE CUT.

DEPRESS THIS LEVER TO THE RIGHT TO  
ENGAGE THE CUTTER BLADES.

ENGAGING FOR LEFT SIDE CUT.

DEPRESS THIS LEVER TO THE LEFT TO  
ENGAGE THE CUTTER BLADES.

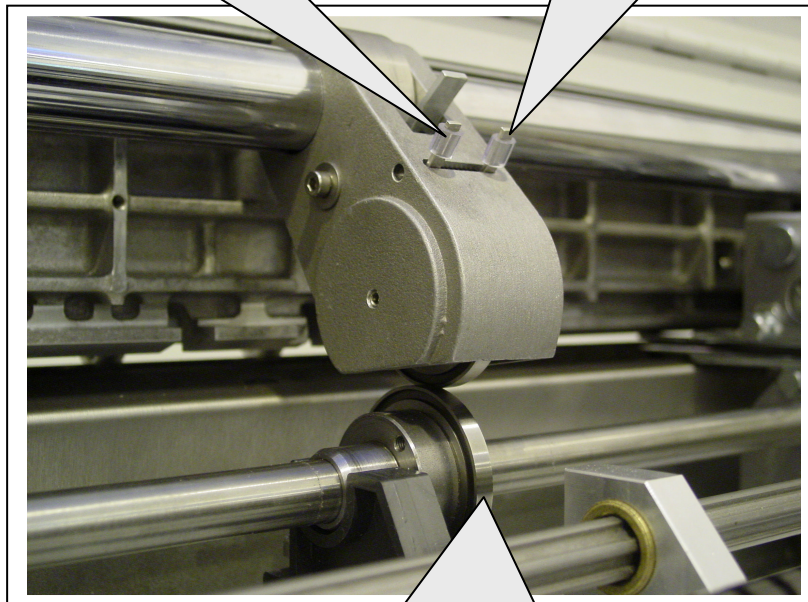

THE CUTTER BLADES CAN BE ENGAGED ON EITHER SIDE.

**Fig 3.9 Setting the Centre Cutter**

### Start Continuous Operation

- Once satisfied that the machine is operating correctly in manual operation, select Continuous mode by pressing the self-locking Continuous pushbutton and press START. The machine will now cycle at the values previously set. This applies to cut and no-cut operation.

### Stop Continuous Operation

- Press the STOP pushbutton or release the Continuous pushbutton to interrupt continuous operation. The machine will, however, continue its current cycle and then stop. This applies to cut and no-cut operation.

### Emergency Stop Operation

- Open the protective cover. The machine will stop immediately in mid-cycle. To start again, close the cover and resume the normal operating procedure from the beginning.
- Note that this method of stopping the machine is bad practice and should not be used for normal operation. This applies to cut and no-cut operation.

### Paper Run-out

- The machine will continue to cycle until the trailing edge of the paper web passes over the paper run-out switch. When this happens, the machine will stop, leaving the last forms unprocessed. This applies to cut and no-cut operation.
- In this instance, de-select the Continuous pushbutton and cycle the remaining forms through manually, by pressing the START pushbutton, using the In-Feed pushbutton to advance the paper and the Manual Blade pushbutton to cut the remaining forms.



## OPERATIONAL MAINTENANCE

## SECTION 4

### WARNINGS

Before starting any preventive maintenance, ensure that the forms cutter has been disconnected from the main electrical supply.

The angular blades on the side trimmers, the centre cutter and the cross-cutter are extremely sharp and care should be taken to protect fingers when the protective cover has been opened.

### CLEANING

- Remove any paper dust or other debris from the inside of the paper transport deck, using an air line or vacuum cleaner. This should be checked on a regular basis and performed as required.
- Open the tractor units and remove any paper dust.
- Clean away any ink residue or other tenaciously adhering debris from bare lubricated parts with a clean cloth.
- Remove each side trimmer guide by slackening the thumbscrew on the side of the trimmer block, as shown in Fig 4.1. This gives access to the trimmer blades. Clean the side trimmer blades using an airline and a soft-hair hand brush.
- Clean the centre cutter blades using a soft-hair hand brush.
- Never use a metal instrument to remove paper debris adhering to the blade surfaces.
- Clean the protective cover using a foam cleaner.

### LUBRICATION

- Lightly oil the tractor unit drive bushes. Loosen their clamps and slide the units along the splined shaft to spread the oil.
- Lightly oil the centre cutter bush, which runs in the centre bridge (see Fig 4.1).
- In order to gain access to the lubrication points on the cross-cutter, the protective cover over the cutter must be removed. This is a task for a service technician and should not be attempted by the operator, unless trained in this procedure by Spedo UK Ltd.

### WARNING: Lithium Batteries

- Lithium batteries are used in the equipment, therefore,
- DO NOT dispose of in a fire.
- DO NOT open, crush, dismantle or otherwise mechanically interfere with any part within the forms cutter that contains a Lithium battery.
- Ensure safe disposal of the any part containing a Lithium battery at the end of the battery life.
- In case of fire, use a dry powder extinguisher based on graphite or other suitable extinguisher for alkaline metal fires.

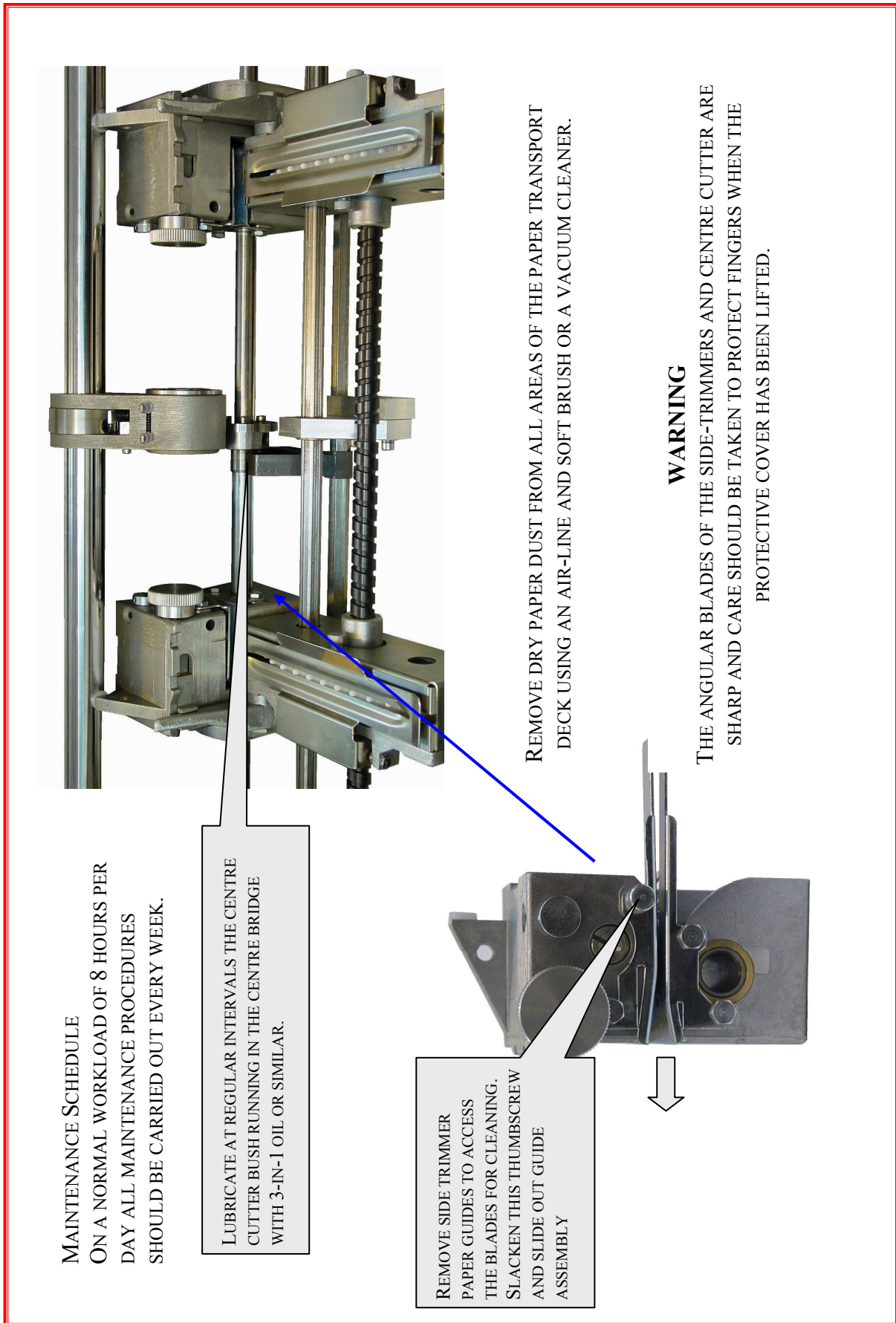

Fig4.1 Cleaning & Lubrication Areas